

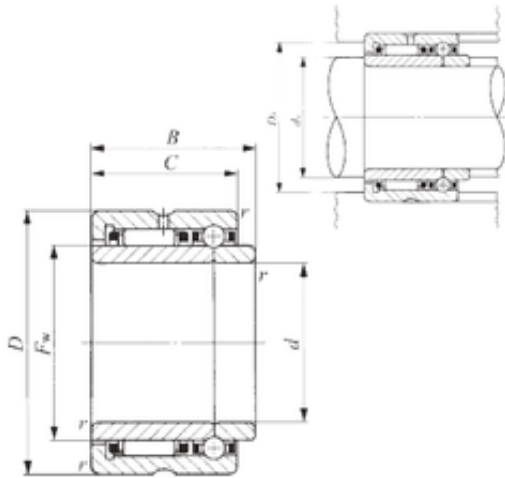

CSC BEARING GROUP limited



45 mm x 68 mm x 34 mm IKO NATB 5909 Compound bearing

Bearing No. NATB 5909

Size	45x68x34 mm
Bore Diameter	45 mm
Outer Diameter	68 mm
Width	34 mm
d	45 mm
Fw	55 mm
D	68 mm
B	34 mm
C	30 mm
r min.	0,6 mm
da min.	49 mm
Da max.	64 mm
Weight	0,435 Kg
Dynamic load rating radial (C)	32,6 kN
Dynamic load rating axial (C)	5,45 kN
Static load rating radial (C0)	68,5 kN
Static load rating axial (C0)	12,7 kN

NATB 5909 Bearing 2D drawings and 3D CAD models