

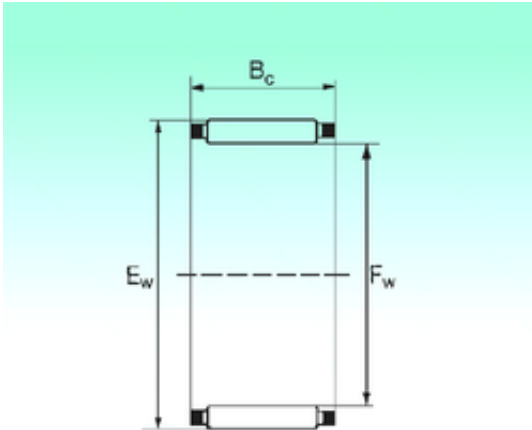

## CSC BEARING GROUP limited



### NBS K 70x76x20 Needle bearing

Bearing No. K 70x76x20

Bore Diameter	70 mm
Outer Diameter	76 mm
Fw	70 mm
Ew	76 mm
Bc	20 mm
Weight	0,07 Kg
Basic dynamic load rating (C)	35,5 kN
Basic static load rating (C0)	85,5 kN

K 70x76x20 Bearing 2D drawings and 3D CAD models